

### Bit and Router Set Up

1. The 3D Router Carver bit includes a round set up jig (see the dotted line in Fig. 1).

Adjust the bit so that the cutting edge is flush with this jig. This ensures that the routed grooves will be the correct depth.

Adjust by loosening the locking nut and turning the cutter in or out as required. (In extremely hard wood it may be necessary to set the bit for a shallow first cut and then set to normal position for the finish cut.)

The set up jig simulates the thickness of the templates and ensures that the cutting tip is just touching the workpiece to begin the carving.

2. Tighten the 3D Router Carver bit into your router collet and release the plunge mechanism, allowing free travel and machine along the plunge guides. Keep the router's plunge guides well-lubricated.

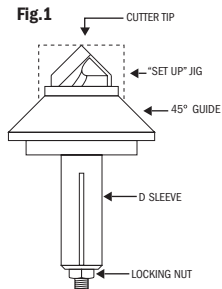

### Frame and Template Set Up

3. Select the required design templates and corresponding holding frame. Secure the holding frame to the workpiece by clamping or tacking (see Fig. 2).

4. Insert one template into the holding frame (there may be up to 4 templates per design). The templates are designed to fit tightly into the frame, and therefore NO separate clamping is required. (see Fig. 3)

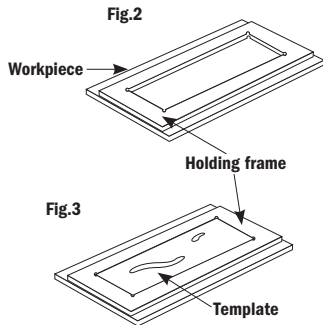

### Routing Technique

5. Start the router and position over the widest part of a slot. Plunge down until the cone shaped guide comes into contact with both edges of the

slot, then move to the end of the slot. By plunging down at the widest part of the slot, the risk of cutting edge coming into contact and damaging the template is reduced.

6. Make one pass through the entire length of the slot. This removes the bulk of the material. Follow up with a finishing pass. Repeat for all slots in the template.

**Notice:** keep a slight downward pressure on the machine as it moves along the slot. The depth and width of the cut will be automatically controlled by the combination of the template and the cone shaped guide.

7. Once all cuts on the first side of the template have been completed, remove and realign the template as indicated in the following section.

### Template Orientation

**Very important:** depending on the shape of the carving design, some templates will be routed one, two, four or 12 times. To determine the proper method for your design, refer to the label on the template package. The label indicates that the design is either "Two Way Symmetrical," a "Corner Design," "Four Way Symmetrical," "Six Way Symmetrical" or "left or Right

**Facing."** Next, refer to the proper carving technique below.

**Notice:** many of the instructions below require you to flip over or rotate templates. If a slot is located in such a way that it will duplicate a slot routed in a previous step, you do not need to rout it again.

### Two Way Symmetrical Design (Fig 4)

1. Notice the "T" engraved in the templates indicating the top of the design.
2. Rout the design, then flip the template over, keeping the "T" at the top.
3. Repeat entire procedure for all templates in this design.

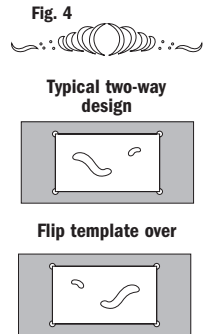

### Corner Design Templates (Fig. 5)

1. Rout all slots in one side of the template
2. Flip the template and rout all slots again.
3. Repeat entire procedure for all templates in each design.

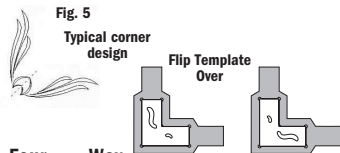

### Four Way Symmetrical Design (Fig. 6)

1. Rout all slots in one side of the template. (notice that there is no top or bottom to these designs).
2. Rotate template 180° and rout all slots again.
3. Flip the template over and rout again.
4. Rotate 180° and rout again (all slots should be routed a total of 4 times)
5. Repeat procedure for all templates in this design.

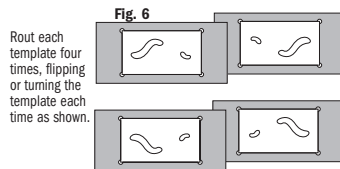

### Six Way Symmetrical Design (Rosettes) (Fig. 7)

Notice: rosette designs can be used separately or added to some of the standard designs. Rosettes 1, 2, 3, 4, can be used with the cabinet door holding frames as well as the rosette frames. Rosettes 5, 6, 7, 8, can be used with the rail frame or the rosette frame.

In these designs each slot is used 6 times on each side. In other words, each slot is used for 12 cuts.

1. Rout all slots in the template.
2. Rotate 60° so the next corner of the template is in the notches in the holding frame and rout all slots.
3. Repeat for all corners on this surface of the template.
4. Flip the template over and repeat the entire procedure.

Notice: when adding rosette designs to the standard designs, it is advisable to leave the holding frame in position. This allows for perfect alignment of the rosette within the existing larger design.

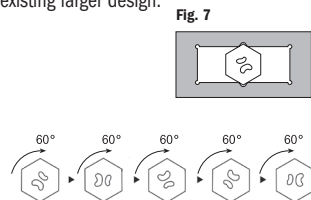

### Left or Right Facing Design (Fig. 8)

1. Notice: the "T" engraved in the templates indicating the top of the design.
2. Very important: notice the "L" or "R" engraved in the templates. This indicates which way the carving will face. For example, the eagle shown in fig. 8 is facing left. Choose which way you want the carving to face, then be sure to use all templates in the same orientation.
3. Rout all slots in each template, being sure to orient the "T" and the "L" or "R" the same way for each template.

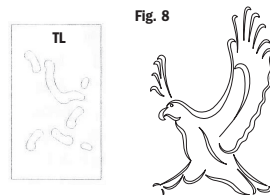

U. S. Patent #5,146,965

TM: CMT, the CMT logos, CMT ORANGE TOOLS and the orange color applied to the tool surfaces are trademarks of C.M.T. UTENSILI S.p.A.

© C.M.T. UTENSILI S.P.A.

This document has been sent for your personal use only. All usage and reproduction is forbidden without written permission from C.M.T. UTENSILI S.P.A.

RCS-INS-USA